

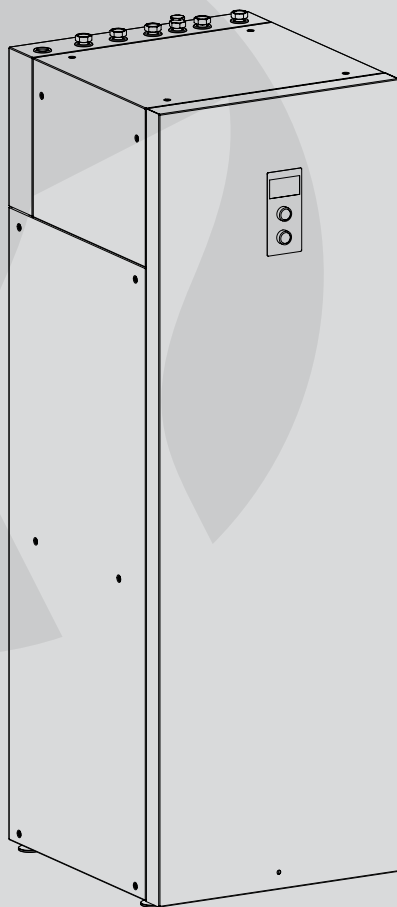

***Bi-functional Electric Central Heating Flow Boiler***



**EKD.M3**

***Assembly and operating instructions***



***This appliance can be used by children aged from 3 years and above and persons with reduced physical, sensory or mental capabilities or lack of experience and knowledge if they have been given supervision or instruction concerning use of the appliance in a safe way and understand the hazards involved. Children shall not play with the appliance. Cleaning and user maintenance shall not be made by children without supervision.***



Used product can't be treated as general communal waste. Disassembled appliance has to be delivered to the collection point of electrical and electronic equipment for recycling. Appropriate utilisation of used product prevents potential negative environmental influences that may occur as a result of inappropriate handling of waste. In order to get more detailed information about recycling this product you should contact the local government unit, waste management service or the shop where this product has been purchased.

## Safety instructions

1. Read and strictly follow this installation and operating instructions to ensure a long life and reliable boiler operation.
2. An efficient electrical installation which has been completed in accordance with the binding norms.
3. Central heating system equipped with an appropriate expansion vessel completed in accordance with binding norms of hydraulic installation.
4. Rinse the heating installation thoroughly before installing the boiler.
5. Do not install any barrier fittings (e.g. valves) on the outlet of the safety valve.
6. Boiler can only be installed on the flat surface.
7. Boiler must not be installed in a humid place, in a place exposed to the danger of explosion, or in which the temperature may drop below 0°C.
8. Boiler must be installed in such a place and in such a way in order not to flood the room in case of the emergency water leak.
9. Boiler must be connected to water system and central heating system in accordance with the manufacturer's instructions. Failure to do so deprives the user from the warranty rights and may cause device's damage.
10. Installation of the device to the water supply must be compatible with all relevant regulations in force.
11. Maximum pressure of the hot water storage must not exceed 0,3MPa. If system's pressure is higher than 0,6MPa, pressure reducing valve must be fitted before cylinder.
12. Water dripping from safety valves' down pipe is a natural occurrence and it should not be stopped, as its blockage may lead to the device's failure.
13. It is forbidden to use the hot water storage if you suspect that safety valves may be faulty.
14. The tank is equipped with a magnesium anode - an additional protection against corrosion. The anode is an operating part, therefore, it is exposed to wear. The condition of the magnesium anode should be controlled every 12 months, however, it is due to be replaced with a new one every 18 months.
15. The boiler installation and electrical and hydraulic work must be performed by a qualified professional installer in accordance with all instructions provided by the manufacturer.
16. All installation work must be performed when the power and water supply are turned off.
17. Electric installation should be equipped with residual current protective devices and other solutions which will ensure disconnecting the heater from the source of power (intervals between all their poles should not be less than 3mm).
18. Electronically controlled heater is a electrical surge sensitive device, therefore the electrical installation must contain surge protection devices.
19. Do not drain the water from central heating system after the heating season.
20. Leave the controller in stand-by mode and do not cut off power supply between the heating seasons. Proceeding otherwise may result in pump's rotor blockage.

## Installation notes

Boiler EKD is equipped with expansion vessels for central heating system and for DHW (12 l capacity). The expansion vessel installed within the boiler for the central heating system is sufficient only for the following capacities of the heating system at given temperatures of the medium and at given pressure of central heating system.

Temperature of heating medium (supply and return)	Capacity of central heating system	Pressure in central heating system
[°C]	[l]	[bar]
85/70	116	1,5
70/55	158	
55/45	206	
50/40	230	
45/35	256	

Shall the capacity of the central heating installation be larger, an extra expansion vessel must be installed (in accordance with binding norms).

If the boiler is to co-operate with under floor heating, it is necessary to install safety armature.



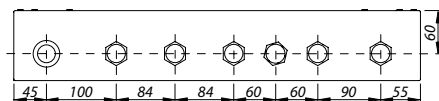
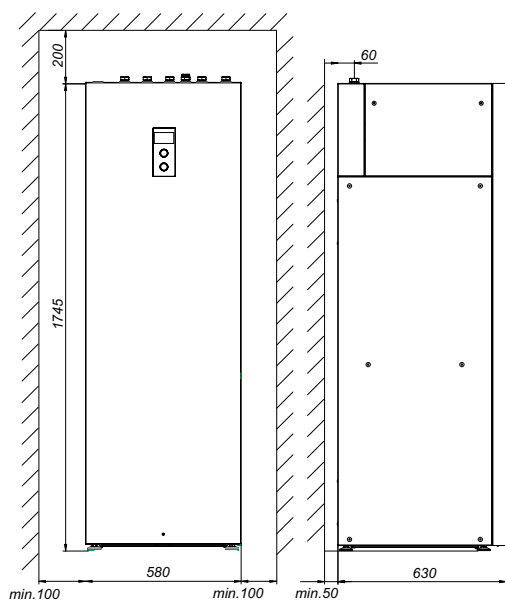

## Installation

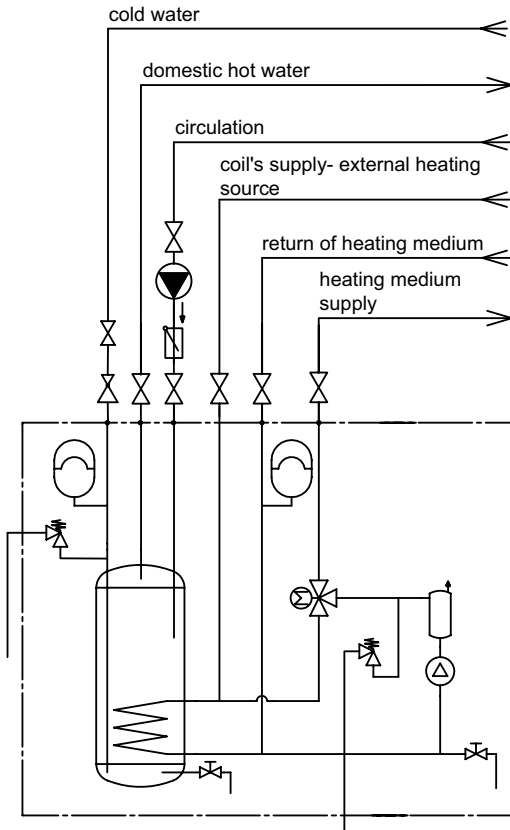
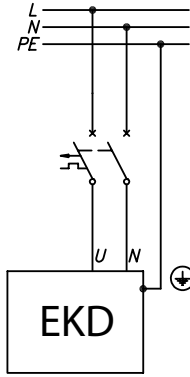
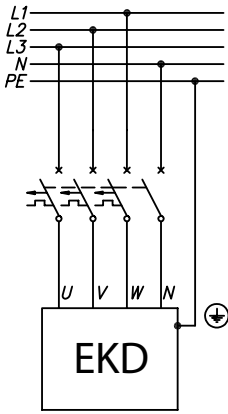

1. Install the boiler on the solid surface, maintaining clearances from the walls and the ceiling. Set the device horizontally by adjusting device's regulation feet.
2. Connect the boiler to the central heating system equipped with cut-off valves. Description of the connectors on page 5 and 10.
3. Fill the central heating system with treated water or ERGOLID EKO liquid it substantially extends the life of the heating elements. When designing heating installation heating medium filling point must be provided. It is recommend to place it as close the boiler as possible.

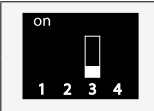

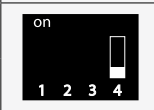
4. Vent the central heating system.
5. Boiler's installation to the water system has to be carried out in accordance with valid norms safety valve must be installed on cold water inlet.
6. Hot water outlet has to be connected to the 3/4" connection which is placed next to the supplying connection.
7. If in the DHW system there is a circuit, it has to be connected to the 3/4" connection which is placed next to the hot water connection, whereas the circuit pump has to be connected to PUMP.C clasp on the terminal block.
8. Extend the pipes placed on the back wall of the device, responsible for safety valve's leak, and locate them as near the floor drain as it's possible. (Safe and reliable operation, point 12.).
9. Connect the boiler to the electrical system.
10. Fix internal (room) and external temperature sensors and other external appliance switch cooperate acc. to 'Connection of external appliances & Controls'.
11. Once the above steps are completed, you can start the boiler and perform venting procedure. (Configuration-Pump-Venting)
12. Set the max. temperature of the heating medium in the installation (Configuration-Central heating-Max power temperature).

	Type of electrical installation- switch No.3	 3 phase
	RS 485 terminator- switch No. 4 (see operating manual for the module connected to the socket of boiler's remote control)	 ON  OFF

**NOTE: switch No. 1 and No. 2 must not be changed!- factory settings must be retained.**

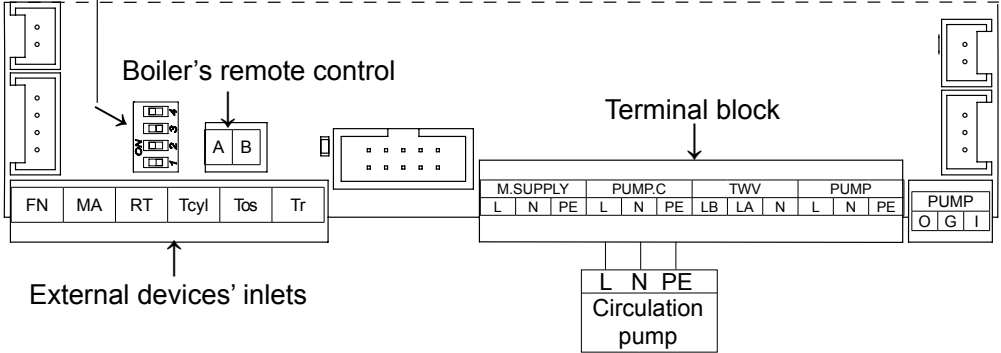

*Connection to the three-phase electrical system.*

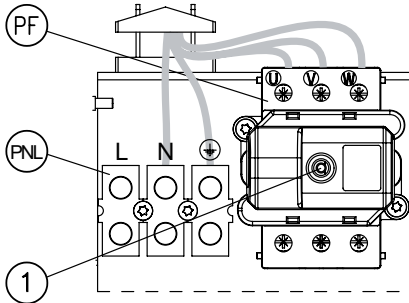

*PNL - points of neutral and protective conductor connection*

*PF - points of phase conductors connection*

*[1] - temperature limiter (for boilers of 4kW, 6kW and 8kW- additional conductors [2] have to be removed and phase switches for the electrical installation have to be changed from single-phase to three-phase)*

*Connection to the single phase electrical system (for boilers of 2kW, 4kW, 6kW and 8kW)*

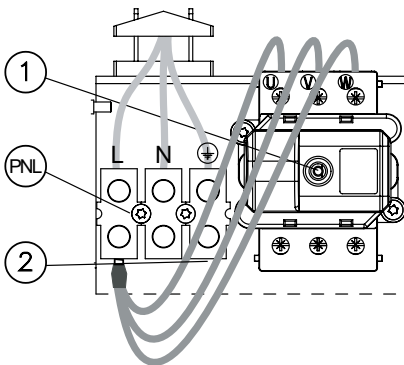

*PNL - connection points of neutral, protective, and phase conductors*

*[1] - temperature limiter*

*[2] - additional conductors (for single phase system only)*

## Connection of external appliances

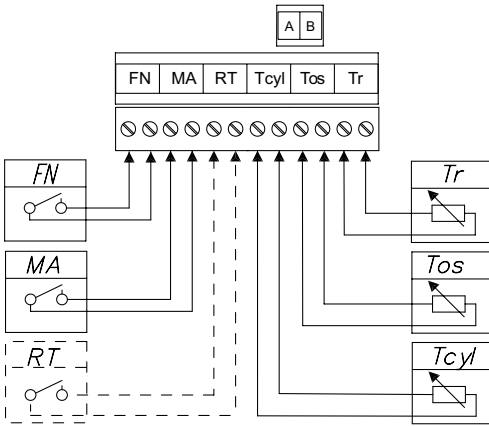

*FN - external adjustment of selected room temperature*

*MA - master appliance*

*RT - alternative room thermostat*

*Tcyl - cylinder's temperature sensor*

*Tos - outside temperature sensor*

*Tr - room temperature sensor*



***Under no circumstances should any voltage be connected to these terminals (FN, MA, RT, Tcyl, Tos, Tr), as this will result in the damage of boiler's controller.***

**Temperature sensors** - Temperature sensor's wiring should be as short as possible, it should not be led close to the power cord and it must not be twisted around other wires. Install the outside temperature sensor (Tos) in the shade, on the north or northwestern facade of the building, away from windows and ventilators. Install the room temperature sensor (Tr) in a representative room in the building (such as a living room), away from heaters, windows, doors, and communication lines.

**Master appliance (entry MA)** - In order to limit the power used, i.e. the boiler can cooperate with other appliances such as an electric water heater. In order to do so, an electrician should install in line an extra open contact to the MA entry (voltage free entry), so that when a master appliance gets on, the contact opens, and the boiler switches off- it results in heating blockage and pump's standstill.

**External adjustment of selected room temperature (inlet FN)** - Closing FN contact shifts boiler's work to the mode of maintaining the temperature previously set in the configuration menu (Configuration>FN entry).

**Room thermostat (entry RT)** - This optional entry is responsible for boiler's control depending on the room temperature. The entry has to be activated (Configuration>Room temperature>Set outside room sensor)- when the voltage-free contact gets opened, the boiler stops heating. Due to such adjustments, central heating system works with stable parameters. (Configuration>CH circulation>Power temperature MAN).

**Boiler's remote control** - In order to control boiler's work remotely via online web page, it is possible to connect the boiler to the Internet module (MI). Installation of MI module is described in the module's manual.

## Operation

Boilers are safe and reliable devices provided that the users follow the regulations below:

- The wear condition of the anode must be inspected annually.
- The anode must be replaced once every 18 months.
- Heat up the water above 70°C periodically for hygiene reasons.
- Failures or malfunctions notify to the manufacturer's service.

Above activities are beyond of the scope of warranty service (should be done by the user).

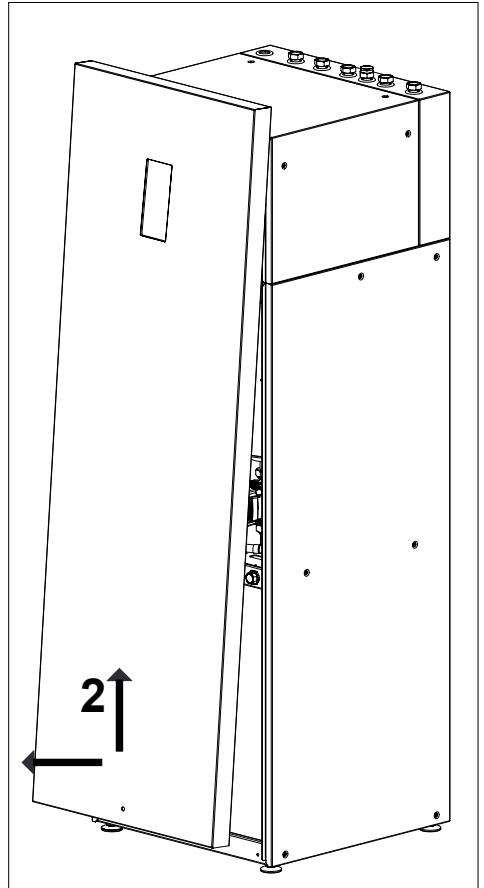
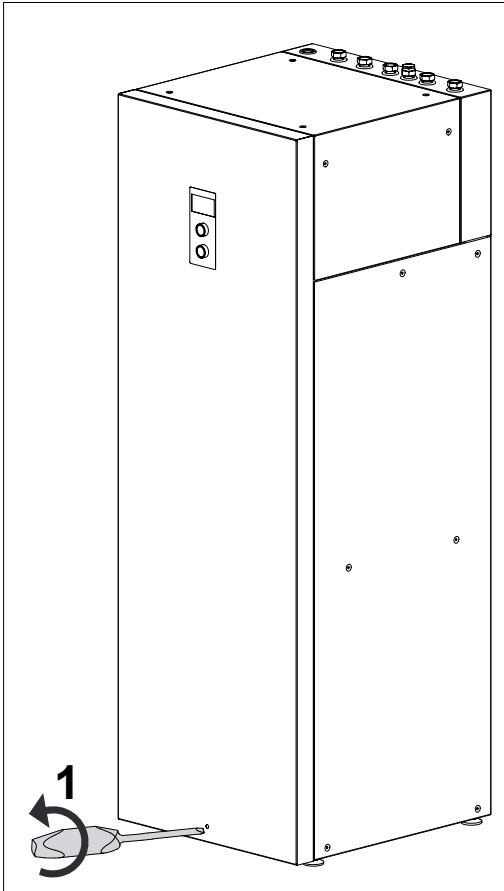



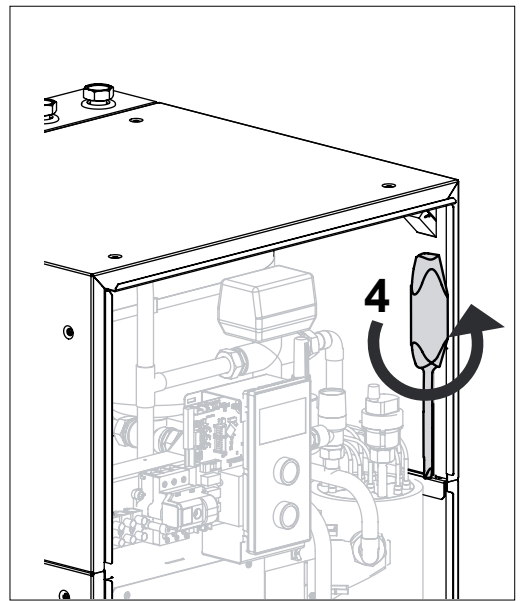
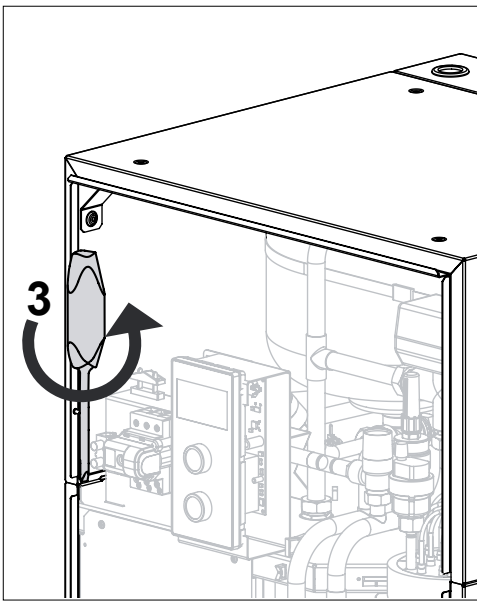

## Anode rod replacement

- Take off the front lid by loosening the bottom screw (1). Tilt bottom edge of the lid and lift it up, so as to take it out of the lashing points (2).
- Disconnect protective conductor from the bottom and upper lid.
- Undo two screws holding upper lid (3) (4) and take the lid out by tilting it towards the back (5).
- Turn off the cut-off valve on cold water supply pipe, turn on the hot water valve (mixer tap), turn the drain valve on [9], drain as much water as you need to easily unscrew the anode rod (avoiding room flooding). Remove the cork and unscrew the anode rod [7] (use wrench no 27).

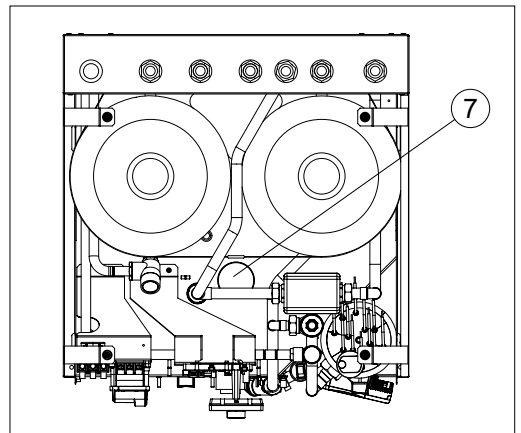
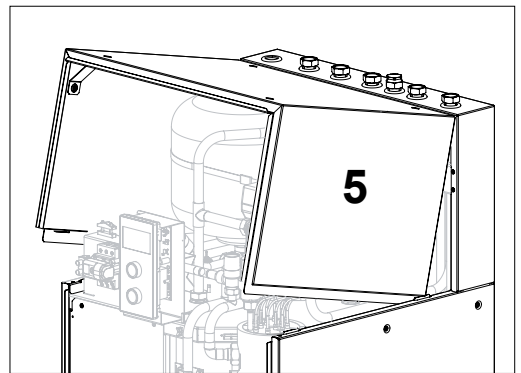

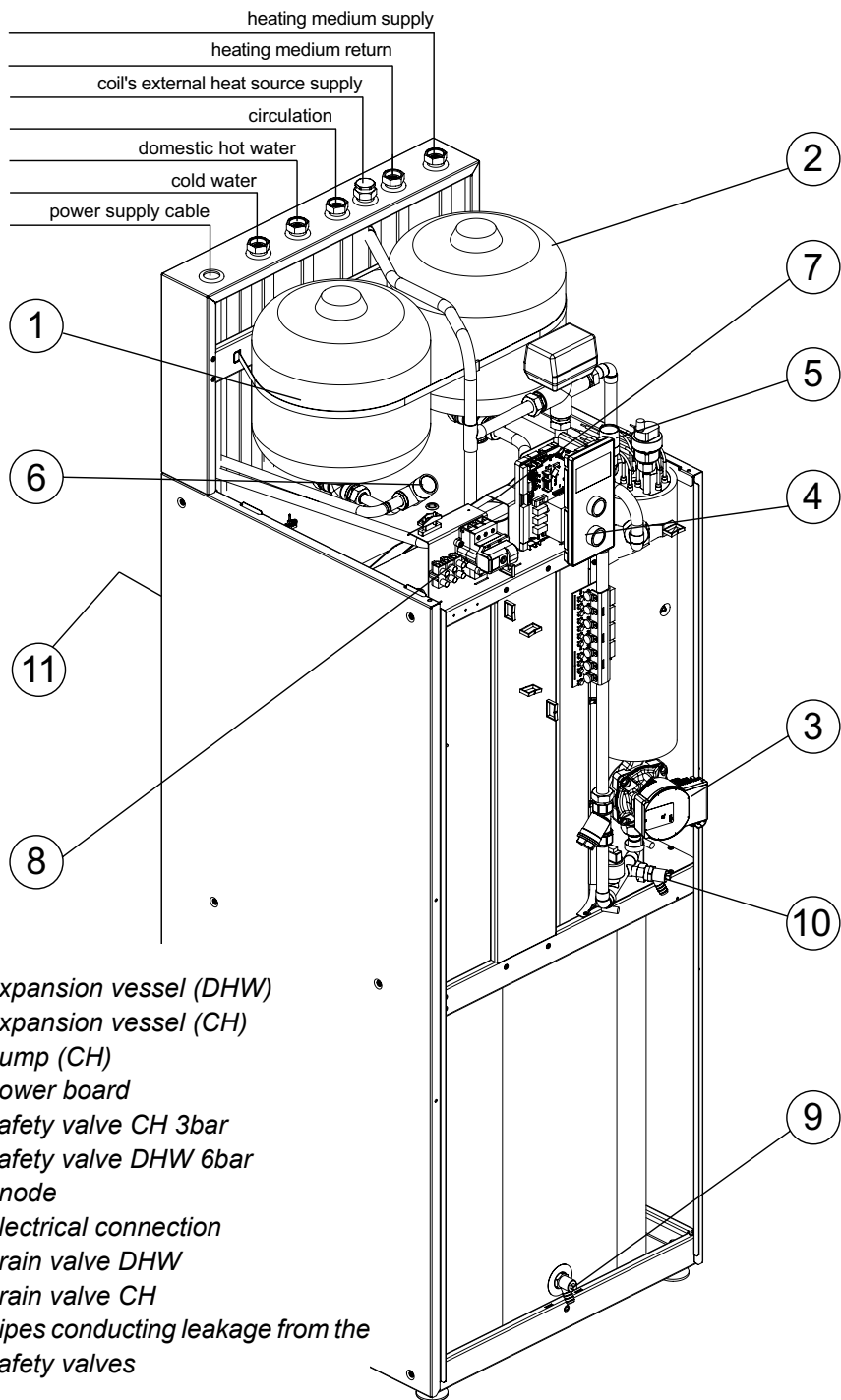

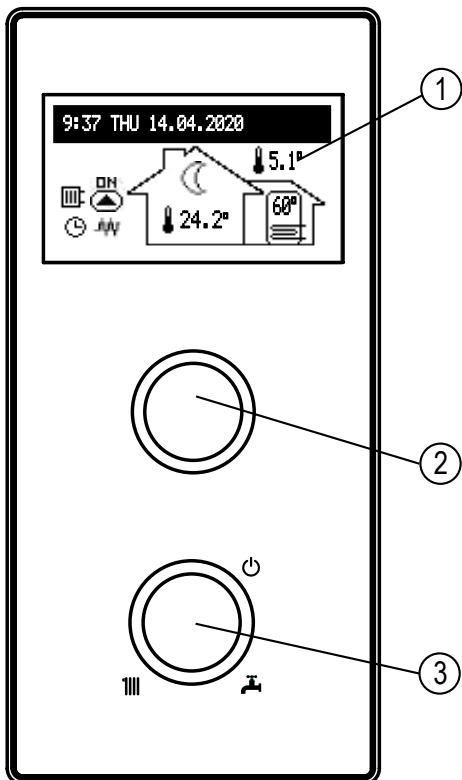

- [1] - expansion vessel (DHW)
- [2] - expansion vessel (CH)
- [3] - pump (CH)
- [4] - power board
- [5] - safety valve CH 3bar
- [6] - safety valve DHW 6bar
- [7] - anode
- [8] - electrical connection
- [9] - drain valve DHW
- [10] - drain valve CH
- [11] - pipes conducting leakage from the safety valves

## Control panel



Use the operating dial [3] to set one of the modes: winter  / summer  / off .

By turning the navigation dial [2] (left or right), with winter or summer mode active, change between function screens on the display [1].

- main: informs about the basic parameters of the boiler (see details in the table),
- settings: allows to adjust the parameters of the boiler to user's preferences,
- service / configuration: allows configuration of the system heating to the conditions of the facility (available for specialized services) and preview of boiler's input and output signals,
- party / holiday / manual: allows to quickly switch work algorithm depending on user's needs.

[1] - display

[2] - navigation dial to preview dial and settings

[3] - operating dial to choose mode









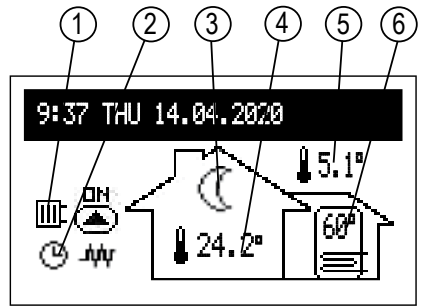









Entering individual functions takes place after selecting a corresponding function screen and pressing the navigation dial.



Boiler's error is signalled on the main function screen.  After pressing the navigation dial, there is a list of detected errors available.

## Main screen

- [1] - heat reception
- [2] - executing of a heating program
- [3] - temperature settings for the room
- [4] - room temperature
- [5] - outside temperature
- [6] - storage temperature









Heat reception	
	Hot water heating/ storage heating
	Central installation heating
	Buffer charging
Executing of a heating program	
	According to a set daily/ weekly schedule
	PARTY - keeping the room and storage temperature comfortable
	HOLIDAY - keeping the room and storage temperature economical or frost-proof
	MANUAL - keeping the set room temperature
	TURBO - heating up the maximum parameters until the set room temperature is reached
	Implementation of the frost protection program
	Storage disinfection
	Circulation pump venting
<b>MA</b>	Heating blocked by signal from master device
Temperature settings for the room	
	Frost protection
	Economic temperature
	Comfort temperature
	Comfort temperature plus
	Comfort temperature minus
	Request for heating from room regulator (with the internal regulator)
	Signalling the implementation of buffer loading according to the schedule

	Device's error indication
	Circulation pump operation indication
	Heating on indication

## SETTINGS:



Adjusting boiler's parameters to user's preferences

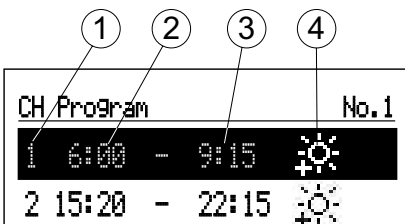

- ROOM TEMP (available only in basic mode and with activated I/S [Configuration room temp > temp sensor > room temperature sensor]):
  - Economic , Comfort - , Comfort , Comfort+ : setting room temperature values in available schedules,
  - Party, Holidays: select temperature parameters for programs: PARTY & HOLIDAYS
- TANK TEMP (available only in installation with domestic hot water cylinder and with activated outside regulation. [Configuration > hot water > regulation > inside]):
  - Economic , Comfort : setting hot water temperature values available in schedules,
- CH PROGRAM (only available in basic mode and source with activated sensor Tr [Configuration > room temp > temp sensor > room temperature sensor]):



- [1]- no. of time frame according to schedule (max 5)  
 [2]- time of starting the selected temperature  
 [3]- time of finishing the selected temperature  
 [4]- temperature selection: 

- No. 1...No. 8 > setting 8 daily programs. In each daily program there are 5 editable time frames, which can have one of the room temperature sets ()  
 In any other case, the economic temperature will be activated ().  
 Setting up daily programs procedure is described in Daily Schedule paragraph.
- Weekly: assigning for each week day one of the previously set daily programs.

- Buffer program (only available in buffer's mode).

	1	2	3
1	6:00	-	8:00
2	18:30	-	23:00

1 - the number of the time interval (max.5)

2 - start time of buffer charging

3 - finish time of buffer charging

- No 1...No8 - setting of 8daily programs, in each daily program there are available 5 time intervals in which cylinder buffer will be charging. Setting procedure of daily programs is described in daily timetable.
  - Weekly: assignment of one of the daily programs set for each day of the week
  - DHW TANK PROGRAM (available only for storage tank systems):
  - No. 1...No. 8 > setting 8 daily programs. In each daily program there are 5 editable time frames, which can have one of the storage tank's temperatures set (☀, ☀-) In any other case, the economic temperature will be activated (☺).
- Setting up daily programs procedure is described in Daily Schedule paragraph.

	1	2	3	4
1	6:20	-	8:00	☀
2	18:30	-	23:00	☀

[1]- no. of time frame according to schedule (max 5)

[2]- time of starting the selected temperature

[3]- time of finishing the selected temperature

[4]- temperature selection: ☀☀

- Weekly: assigning for each day of the week one of the set daily programs or a permanent program 9 (ECO).  
Program No. 9 ECO is factory-set and it optimizes boiler's operation while domestic hot water is heated in order to achieve the best possible energy efficiency class in accordance with the terms of the ErP Directive. Individual (customized to user's needs) switching time and water temperature programming can decrease or increase energy consumption.

## No 9 ECO Program Schedule

00:00 - 10.00 Tcyl = 40°C  
10:01 - 11.00 Tcyl = 64°C  
11:01 - 20.00 Tcyl = 40°C  
20:01 - 21:35 Tcyl = 64°C  
21:36 - 23:59 Tcyl = 40°C

- CIRCULATION PROGRAM (available only with the active circulation within DHW system):
  - No. 1...No. 8 > setting 8 daily programs. In each daily program there are 5 editable time frames, in which circulation pump is on. Setting up daily programs procedure is described in Daily schedule paragraph.
  - Weekly: assigning for each week day one of the previously set daily programs.

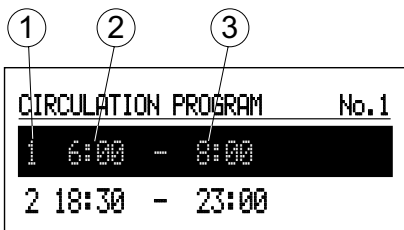

[1]- no. of time frame according to schedule (max 5)  
[2]- time of starting the work of circulation pump  
[3]- time of finishing the work of circulation pump

- DISINFECTION (available only in storage 1 2 3 tank systems):
  - Temperature: temperature of the storage tank during disinfection,
  - Day of the week: day of the week of automatic disinfection,
  - Time: time of automatic disinfection,
  - Working time: disinfection duration,
  - Automatic operation: start disinfection automatically at a given time (Hour, Day of the week),
  - Circulation (available only with the active circulation switched on): a possibility to select disinfection of either the whole installation or just the hot water storage.
  - Start now: start disinfection manually (irrespective of a day and time set previously).
- DATE/ TIME:
  - Setting current system time (year, month, day of the month and day of the week, hour).
  - Automatic time change: yes > automatic time switch from summer to winter mode and reverse.

**Attention: in case of boiler's cooperation with the Internet module, it is required to disable automatic time switch.**

- INTERFACE:
  - Brightness MIN: setting the brightness of the display in stand by mode
  - Brightness MAX: setting the brightness of the display in working mode
  - Sound: acoustic sound of the dial: YES/NO
  - Dial sensitivity: 1- high / 4- low
- LANGUAGE:
  - Select menu language.
- SYSTEM:
  - MSK program: shows program version of boiler's controller,
  - PW program: shows panel's software version,
  - Max power: shows set boiler power,
  - Auto change of time: yes -> automatic switching of system time from summer to winter and vice versa,
  - Reset: restarts the boiler,
  - Factory settings: return to factory settings.

## PARTY / HOLIDAY / MANUAL



Fast changing of the workflow algorithm according to needs.

- PARTY: setting mode duration (from 1 to 24 hours or until cancelled)
- HOLIDAYS: setting mode duration (from 1 to 60 days or until cancelled).
- MANUAL: Set the room temperature by the system control - until cancelled.
- TURBO: turning on the place's heating up with max parameters - until reaching the set room temperature.

**Attention: the option is available if the room temperature falls below the current working temperature resulting from the schedule.**

*\* If any of the above modes are ON, then after entering 'Party / Holiday / Manual' there is a possibility to turn it off, and in case of setting the manual mode, it is also possible to change the set temperature.*

*\* Mode symbol is indicated on the main function screen.*



# SERVICE / CONFIGURATION

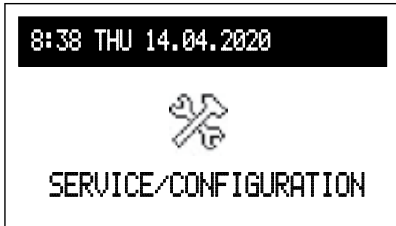

## Preview of parameters:

preview of input and output signals of the boiler.

**Configuration:** adaptation of the boiler to the heating system in the facility.

*\*(Changes in the configuration menu are possible after entering an access code. When prompted for an access code, turn the navigation dial to the required code and confirm the code by pressing the dial. If you want to retract from the code request screen, hold the navigation dial or wait until automatic return to main function screen.)*

**Code : 987**

- Buffer (available only in buffer's mode)
  - Buffer temp: temperature of the buffer charging factor,
  - Load off-program: Yes- means consent to work outside the schedule with parameters according to the needs of the heating modules.
- CENTRAL HEATING:
  - Weather comp.: Choice of heating curve,
  - Offset : offset of the heating curve.
  - MAX boiler temp: The maximum temperature in CH installation.

**Attention: adjustment of too high temperature parameters not compatible with the type of building, central heating installation and building's insulation may lead to high exploitation costs.**

  - Set boiler temp.\*: Temperature in CH installation when cooperating with constant parameters and in emergency conditions.
  - Regulation\* / \*\*: per curve / constant per curve > temperature in CH installation is calculated on the basis of outside temperature and heating curve parameter. Constant > temperature in CH installation is equivalent to Supply temperature MAN.
  - Outside temp OFF: setting of selected temperature above which CH circuit will be switched off
  - Frost protection: frost protection of the building ON

\* not available in buffer mode  
\*\* not available in source mode
- HOT WATER TANK:
  - POWER TEMPERATURE: setting coil's supply temperature.
  - REGULATION: regulation of the temperature in the storage- INSIDE -> acc. to Tcyl/  
OUTSIDE> acc. to outside thermostat (with OUTSIDE settings unavailable menu

positions: tank temperature, DHW tank program, disinfection, and manual)

- UNTIL CALL OFF - turn off the storage circuit.

*\*If Hot Water Tank function is off - menu will only show a possibility to turn it on ('Turn on').*

- CIRCULATION: switching the circulation 'on' or 'off'
- ROOM TEMP:
- ROOM TEMP CONTROL: yes -> heating turned off after reaching the set room temperature.
- ROOM TEMP HYSTERESIS: room temperature hysteresis with 'ROOM TEMP CONTROL' on.
- SET OUTSIDE ROOM SENSOR: shifting boiler's control to the external regulator (RT clasp)

*\*If OUTSIDE regulator is 'on' - menu will only allow switching to INSIDE regulator (set INSIDE ROOM SENSOR), after its selection and re-entering MENU items select settings of the remaining parameters.*

- TURBO:
- ROOM TEMP HYSTERESIS: room temperature fall triggers this function.
- HOT WATER TANK: No - turns off hot water for the Turbo function.
- UNTI CALL OFF - turns off automatic Turbo function.

*\*If Turbo function is off - menu will only show a possibility to turn it on ('On').*

- PUMP:
- PUMPS PROTECTION: time to turn the pump on for a short time at a longer standstill (protection against blocking).
- AUTOMATIC MODE: yes -> works according to user's needs / no -> works constantly.
- TYPE: pump's type.
- REGULATION: constant p. -> constant pressure / variable p. -> variable pressure.

In the regulation mode (constant p.), the pressure difference produced by the pump is maintained at the constant set level in terms of performance to pump's maximum characteristics. This type of regulation is recommended for floor heating circulations or older heating systems with pipes of larger diameters, as well as for all applications with constant characteristics. In the regulation mode (variable p. the pressure difference produced by the pump is maintained at the level of settings changing linearly between 1/2H and H. Setting pressure differences decreases or increases depending on the flow. This regulation type is recommended for heating systems with heaters, thanks to which flow noise in thermostatic valves is reduced.

- VENTING: ON/OFF.  
During venting procedure (10 min) the pump works alternately with a maximal and minimal rotation speed. Thanks to this air bubbles are concentrated and easier to remove from the installation.
- HMAX- pump's raising height.
- MAX RATED POWER: setting heater's rated power.
- COMMUNICATION:
- Device number: device's number on the mains (setting '0' turns off the mains service).

- INLET FN: selection of reaction to closing FN inlet: either setting economy temperature or frost protection.
- PRESSURE CONTROL: no->switching the control off- pressure control should be switched off only when boiler works in the open installation.
- Working mode: standard/source/buffer. Standard > boiler is the only device that controls CH system. Source > boiler is only the heating source and CH circuit is controlled by heating modules (working mode of the system described in operation manual of the heating module). Buffer > boiler supervises buffer charging, buffer's discharge is done by heating modules (working mode of the system described in operation manual of the heating module).

Exit any menu item by pressing 'End' or by pressing and holding the navigation dial. When not operated by the user, main function screen will appear after about 3 min.

## Start-up

With the start-up of the boiler or after the restoration of the factory settings it is necessary to select MENU's language and boiler's rated power. Boiler is ready to work properly only after selection of these parameters.

## Daily schedule:

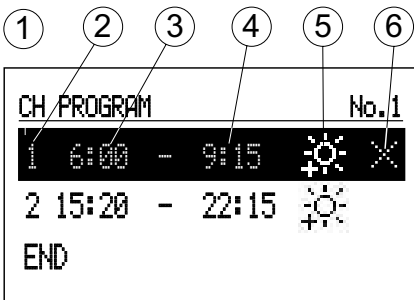

- [1] - time period panel
- [2] - no. of time frame according to schedule (max 5)
- [3] - time of starting
- [4] - time of finishing
- [5] - temperature selection
- [6] - command (active when editing):
  - accept
  - delete
  - add

In daily schedule CH circuit and cylinder have defined starting time (3) and finishing time (4) of maintaining selected temperature value (5) in the room (CH) or hot water (cylinder). Outside defined time frames economy temperature will be maintained in the room/cylinder. For circulation circuit within the schedule there is an adjustment of starting time (3) and finishing time (4) of circulation pump's operation. In buffer mode there is an adjustment of starting time (3) and finishing time (4) of buffer's charging.

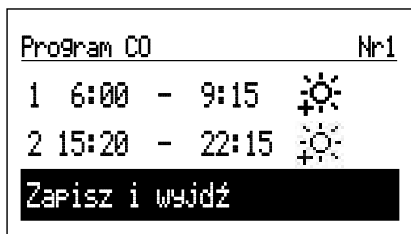

To change the parameters for the daily schedule select chosen program number and press navigation dial.

The first parameter flashes (starting time)- use the navigation dial to set the new time frame value (hour and minutes separately) by turning the dial left/right and confirm it by pressing the dial again. At the same time next screen starts to flash allowing edition of next parameters. (finishing time). Last editable position is a command. In order to save changes select command 'save'  and press the dial to finish editing. To delete selected time frame start editing chosen time frame and

by pressing the dial go to command position, select command 'delete'  and press the dial. To add new time frame, select last defined time frame and by pressing the dial go to command position, select command 'add'  and press the dial to add new time frame. (edition of new time frames described above) If there are no defined time frames, then after selecting 'new' the time frame 00:00am to 23:59pm will be set , which should be edited in accordance with user's needs.

The daily program will be saved to the boiler's settings by pressing the command 'END'.

## TURBO function

If the facility is cold and if it is necessary to heat it up quickly, there is a possibility to turn on the TURBO function. This function, when conditions to turn on the heating are fulfilled, starts central heating installation with maximum parameters and continues until required temperature is reached in a room. This function can start automatically when room's temperature falls down by the set room temperature hysteresis.

Automatic work is set in menu CONFIGURATION > TURBO. Selection of 'Hot water tank- NO' will result in switching off hot water heating priority for the time of using Turbo function. In menu Party/Holidays/Manual it is possible to turn on this function manually (without hot water heating up priority), on condition that the room's temperature is lower than the programmed one. Sensor Tr is required to turn on Turbo function.

## Frost protection

During stand-by and summer modes, if the room temperature drops below 7°C, heating of CH circuit will be activated. Tr sensor is required to activate this function.

The function is disabled when the boiler is controlled by an external room controller connected to the RT input. In this case, the frost protection mode must be enabled on the external controller, the boiler will maintain temperature set manually.

# Heating curve

Boiler's controller is responsible for maintaining proper temperature in central heating installation depending on the outside temperature. While the temperature outside the facility is low, heat demand within the facility is higher, whereas while the temperature outside is high, analogically, there's no need to maintain high temperature within the installation. Correlation between outside temperature and heating installation's temperature can be presented in a graphical form of so called heating curve. The diagram below presents a compilation of heating curves for the set point of room temperature equal 22°C. Depending on the facility characteristics, climate zone, and the type of heating installation one must select appropriate heating curve.

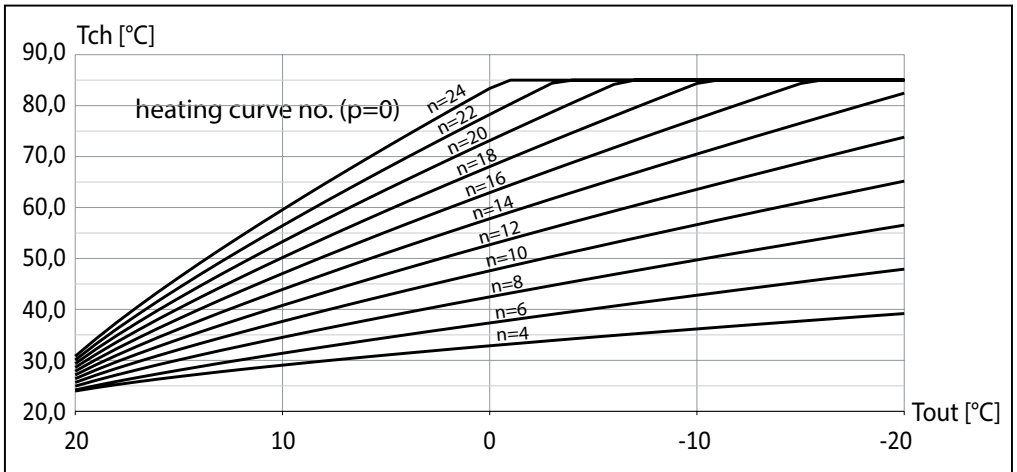

In case of the need to offset the heating curve, it is necessary to change the parameter [heating curve]. The diagram below presents heating curve no. 12 with the offset -10°C and 10°C.

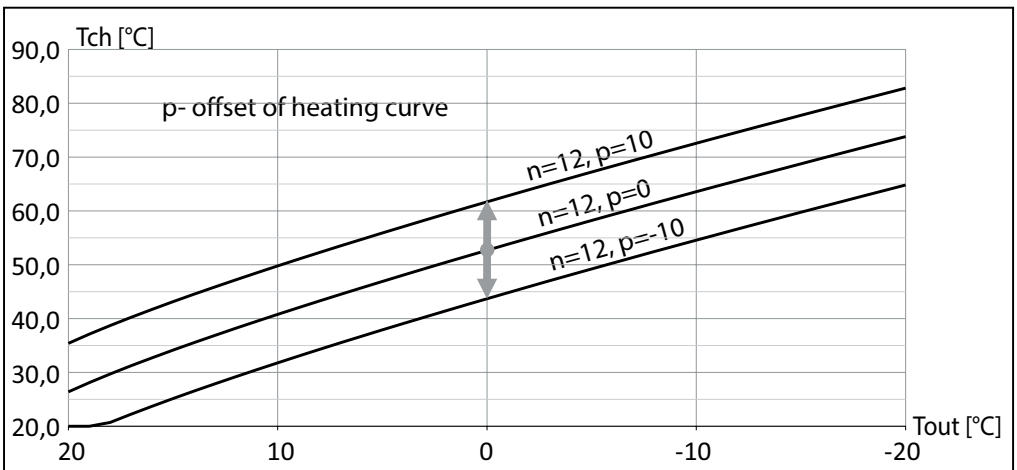

## CENTRAL HEATING BOILER

Max. pressure	MPa	0,3 (3 bar)
Min. pressure	MPa	0,05 (0,5 bar)
Thermal cut-out	°C	t. cut-out 90-99
Outlet flow temperature		20 ÷ 85
Expansion vessel	Capacity	l
	Initial pressure	kPa
Bypass valve	kPa	Adjustable: 10÷50
Safety valve	MPa	Opening pressure: 0,3
Boiler's connections		G 3/4" (inside thread))

## DOMESTIC HOT WATER CYLINDER

Surface area of coil	m <sup>2</sup>	1
Power of coil in temp. 85/65, flow 1,2 m <sup>3</sup> /h	kW	23
Storage capacity	l	130
Rated pressure	MPa	0,6
Safety valve	bar	6
Expansion vessel	Capacity	l
	Initial pressure	kPa
Hydraulic connections		G 3/4" (inside thread))
Magnesium anode 3/4"	mm	660

EKD.M3 BOILER		4 / 6 / 8						
Rated power	kW	2	4	6	8	4	6	8
Rated voltage		230V~			400V 3N~			
Rated current	A	8,7	17,4	26,1	34,8	3x5,8	3x8,7	3x11,6
Min. connecting wires section	mm <sup>2</sup>	3x2,5		3x4	3x6	5x2,5		
Max. connecting wires section	mm <sup>2</sup>	5 x 16						
The maximum allowed network impedance	Ω		0,27	0,17	0,15			0,27
Time of heatng up DHW storage 15°C - 55°C	min	208	107	72	54	107	72	54

EKD.M3 BOILER		12 / 16 / 20 / 24			
Rated power	kW	12	16	20	24
Rated voltage		400V 3N~			
Rated current	A	3x17,4	3x23,1	3x28,8	3x34,6
Min. connecting wires section	mm <sup>2</sup>	5 x 2,5	5 x 4		5 x 6
Max. connecting wires section	mm <sup>2</sup>	5 x 16			
The maximum allowed network impedance	Ω			0,27	0,13
Time of heatng up DHW storage 15°C - 55°C	min	36	29	24	18

Weight	without packaging	kg	115
	with packaging		152
	when filled		255
Dimensions (H x W x D)	without packaging	mm	1745 x 580 x 630
	with packaging		1950 x 655 x 715



**KOSPEL S.A. 75-136 Koszalin, ul. Olchowa 1**  
**tel. +48 94 31 70 565**  
**serwis@kospel.pl www.kospel.pl**